

Letter

Aa

Book



Trace the letters.

A A A A

A

a a a

a

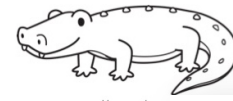
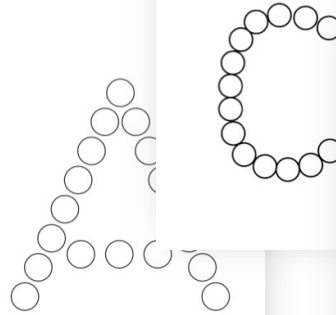

alligator

Homeschool Creations

Aa words I know...



acorn



apple



apron

# Alphabet Booklets – P to T

In this mini packet, you will find alphabet booklets for the entire alphabet. These booklets print double-sided. Once printed, cut along the dotted line. Stack the papers (pages are numbered) and fold in half to create a mini booklet. **Borderless printing is recommend** (an option in printer settings).

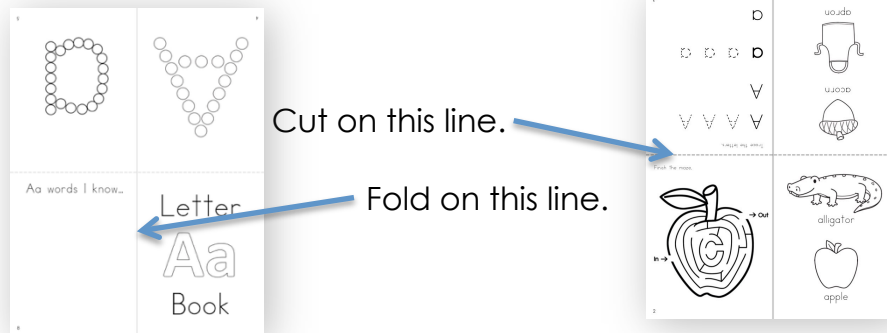

## Page descriptions for each letter:

1. Cover;
2. Finish the Maze;
3. Trace the Letters;
4. Do-a-Dot uppercase;
5. Do-a-Dot Lowercase;
6. Color the Picture Words;
7. Color the Picture Words;
8. Words I Know

© November 2016, www.HomeschoolCreations.net. All rights reserved by author.

Permission to copy granted for single classroom or homeschool use only.

Electronic distribution limited to single classroom or homeschool use only.

If you would like to share, please link to my blog post or website, NOT directly to the PDF file.

Clip Art Credit: Picture Mazes and Phonics Clip Art © Designs by Ramona & Alphabet Worksheet Help / Lowercase Alphabet Worksheet Help

© Hidesys Clip Art via Teachers Pay Teachers / Little Red's ABCs © Little Red's Clip Art via Teachers Pay Teachers

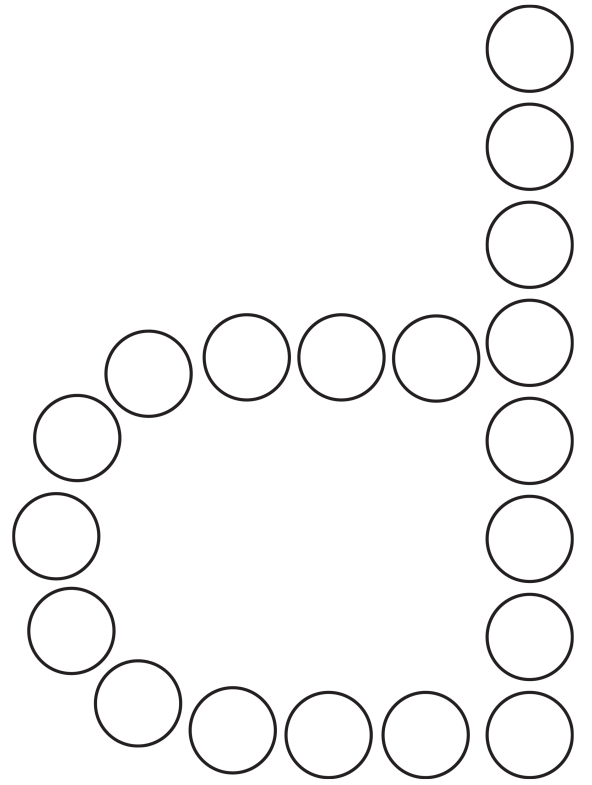
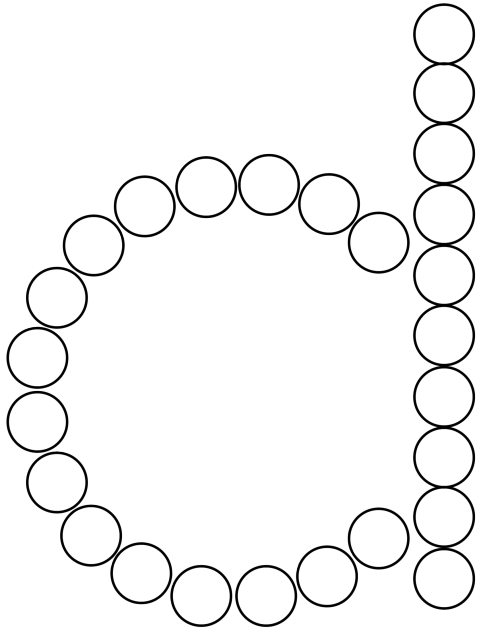

Pp words I know...

Letter

Pp

Book

d

d d d d d

P

P P P P P

Trace the letters.

Finish the maze.

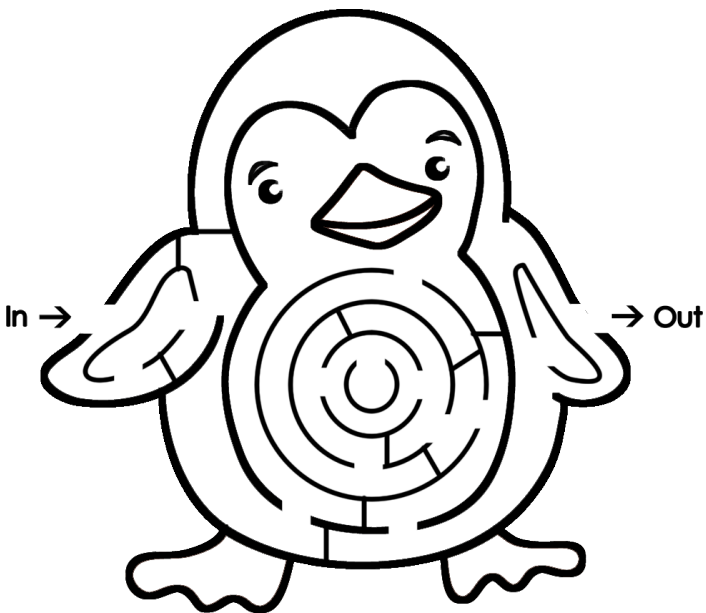

pear

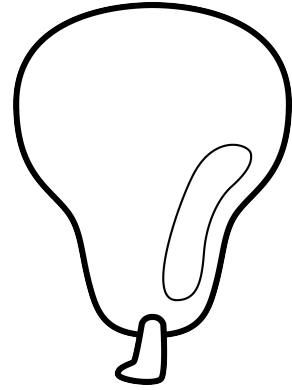

pencil

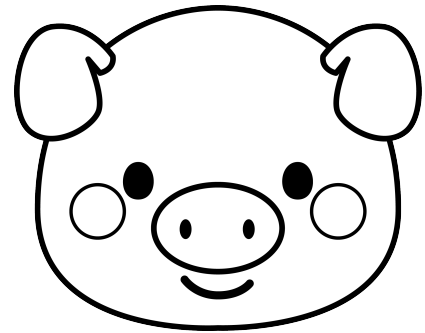
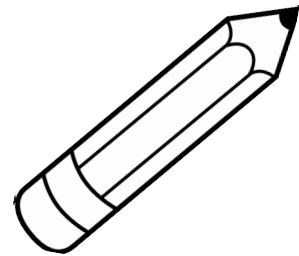

pig

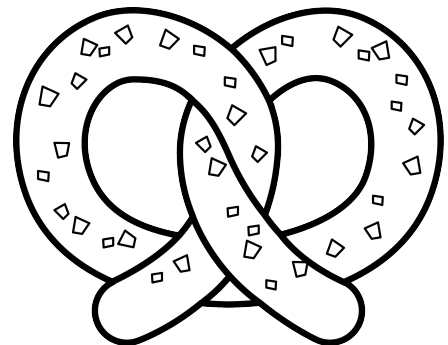

preztel

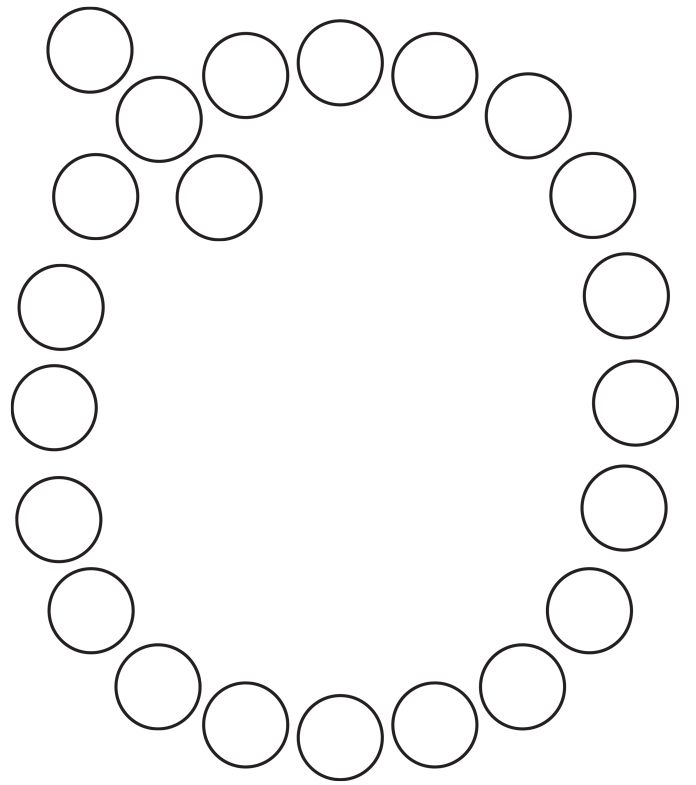
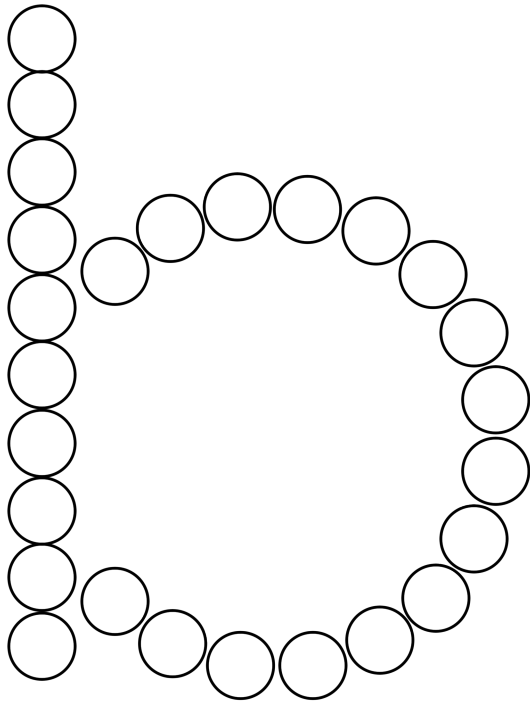

Qq words I know...

Letter

Qq

Book



b

b b b b

o

o o o o

Trace the letters.

Finish the maze.

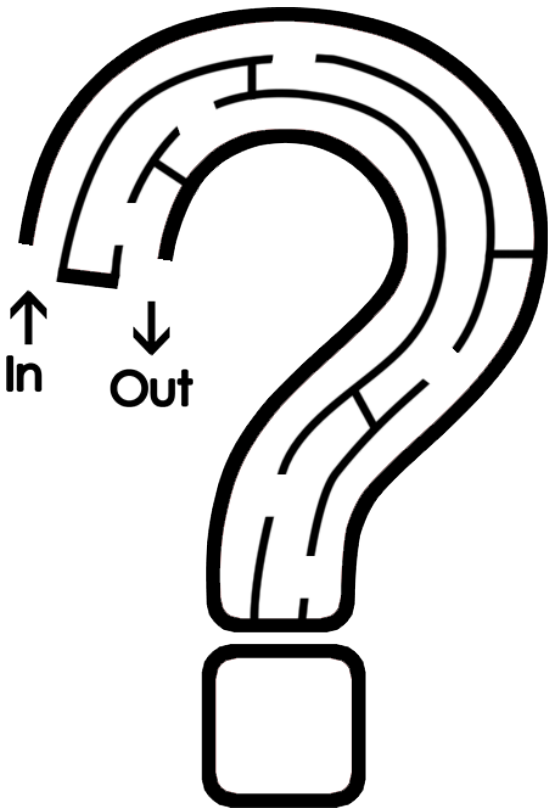

queen

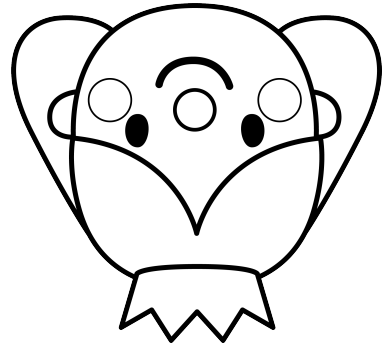

Question

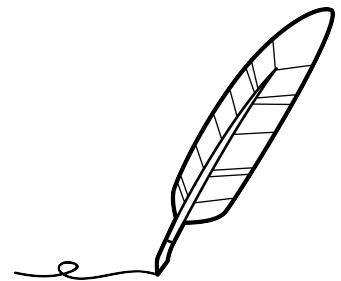
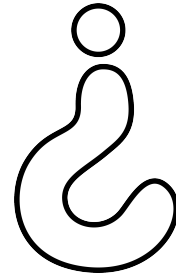

quill

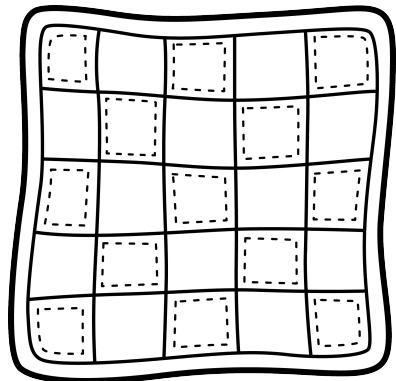

quilt

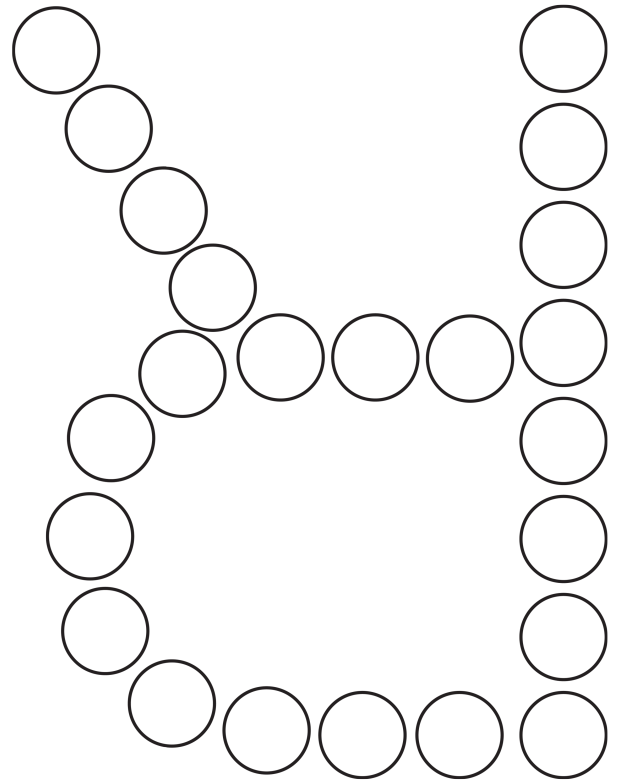
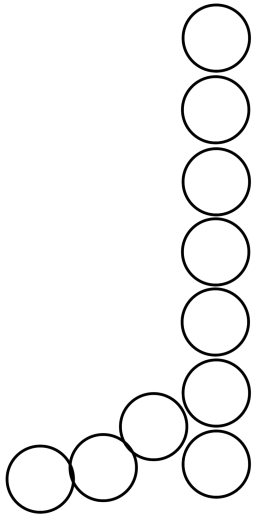

Rr words I know...

Letter

Rr

Book



Trace the letters.

Finish the maze.

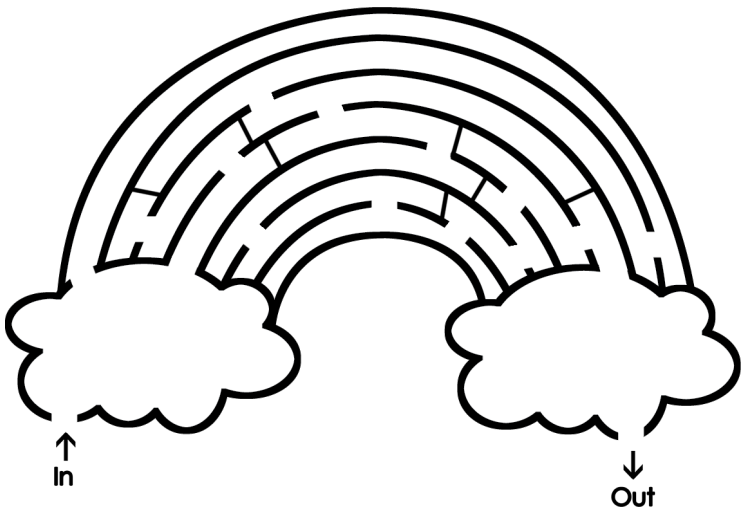

rainbow

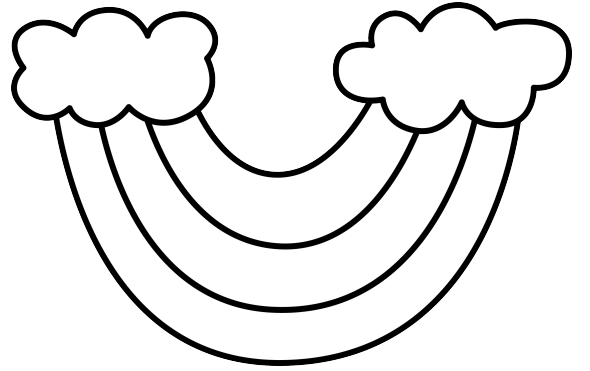

roller skate

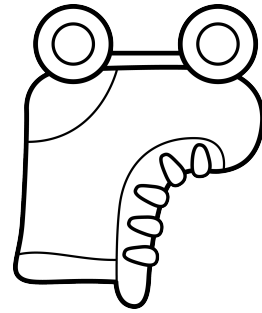

rock

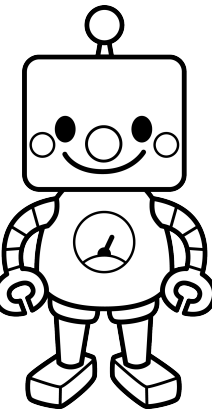
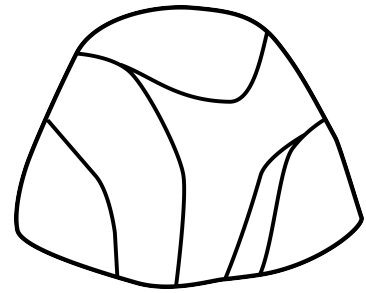

robot

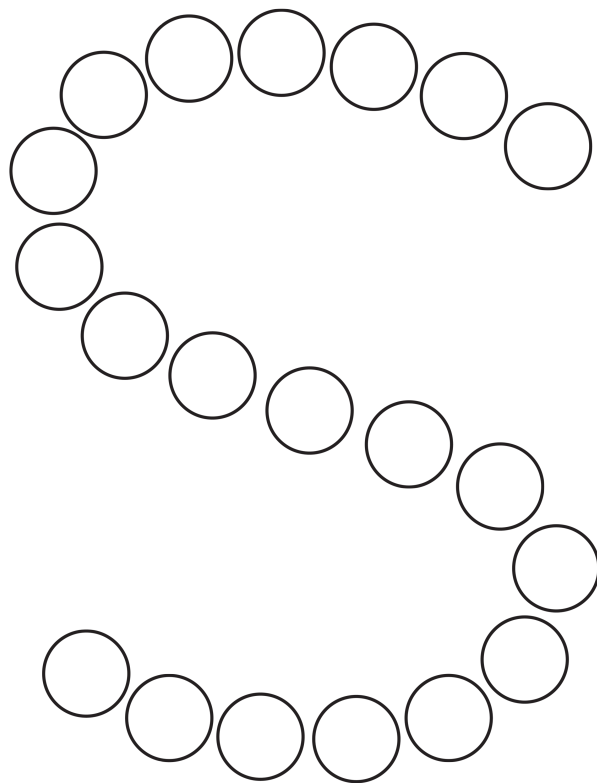
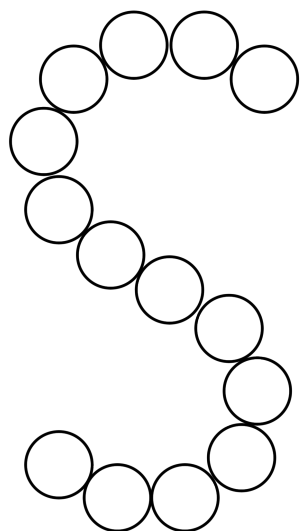

Ss words I know...

Letter

Ss

Book

S

S S S S S

S

S S S S S

Trace the letters.

Finish the maze.

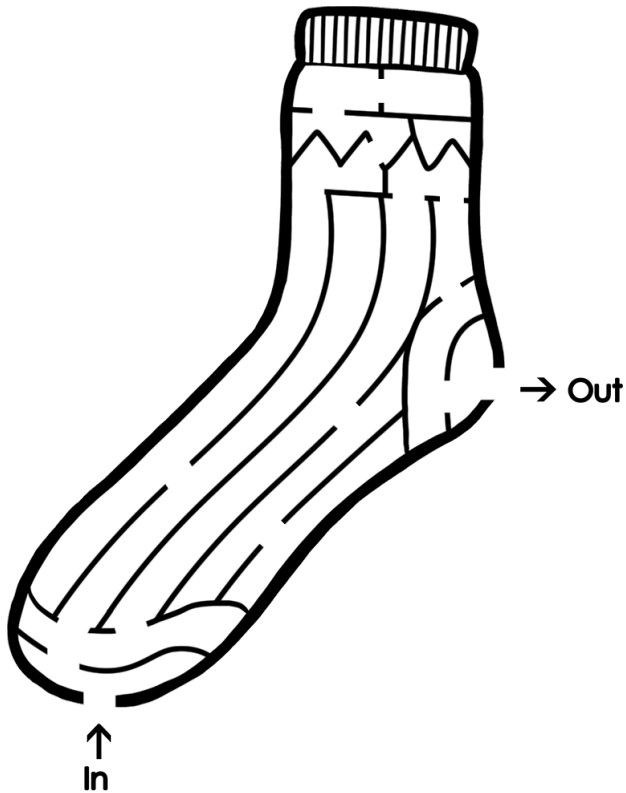

sun

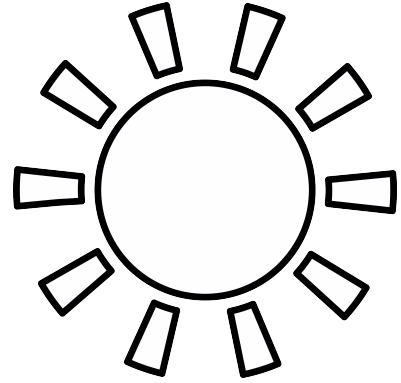

spider

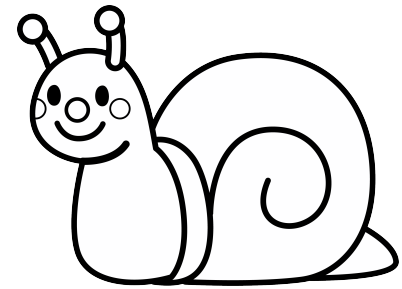
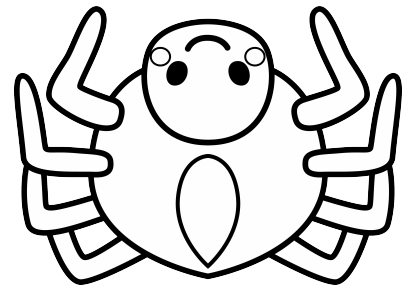

snail



snowman

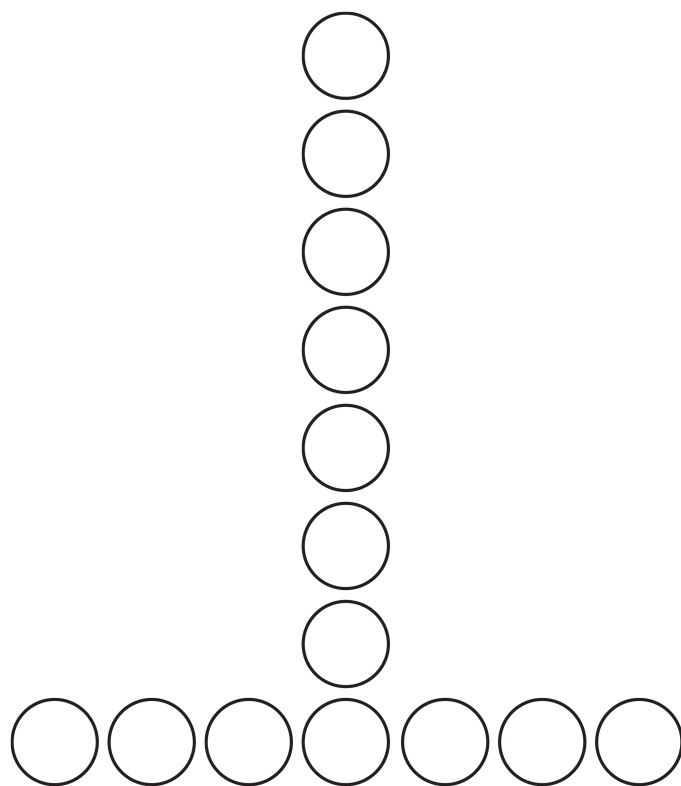
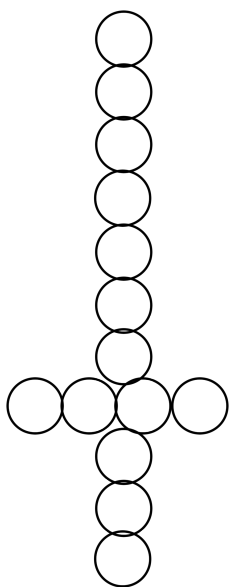

Tt words I know...

Letter

Tt

Book



Trace the letters.

Finish the maze.

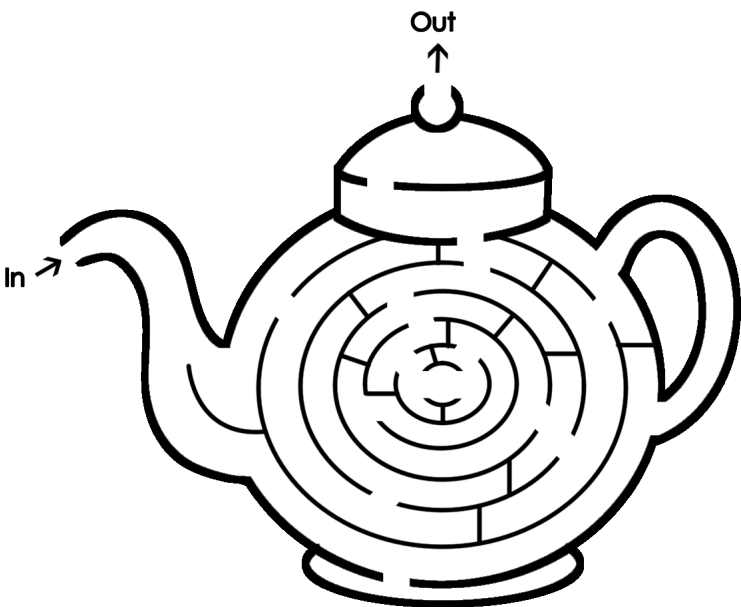

toaster

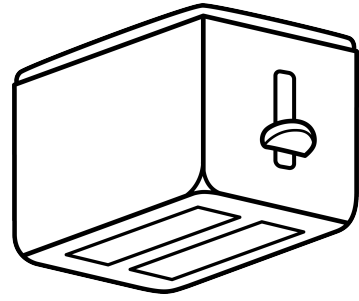

tractor

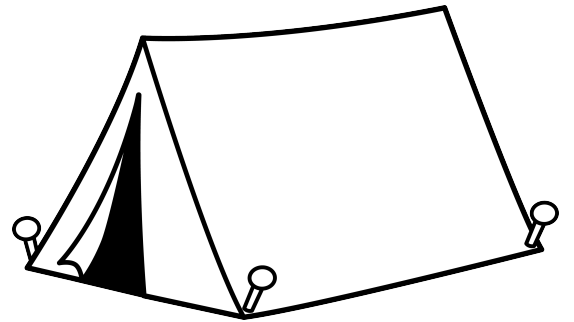
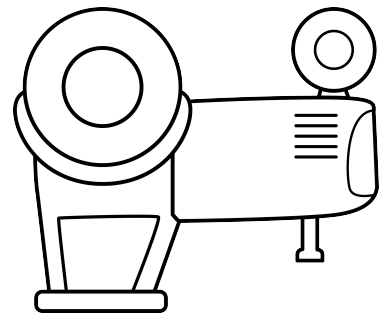

tent

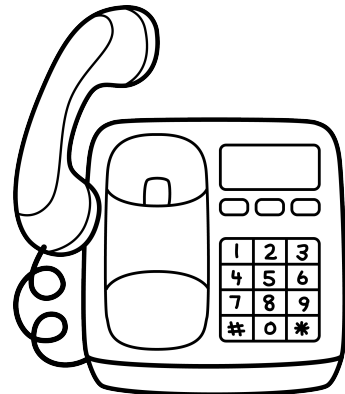

telephone

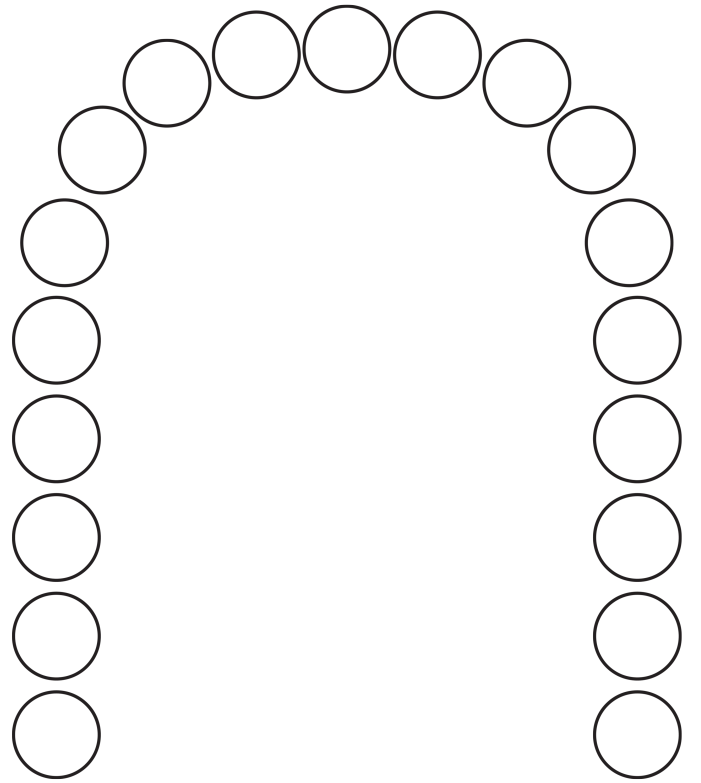
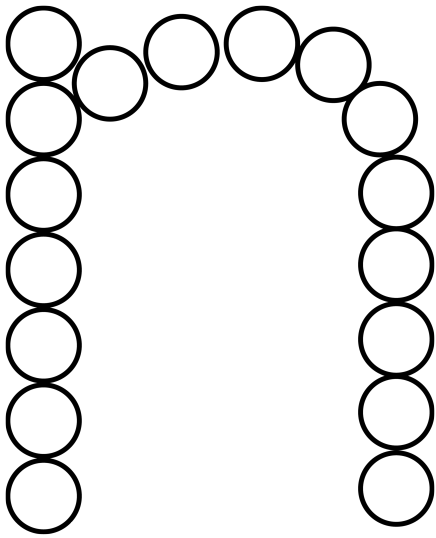

Uu words I know...

Letter

Uu

Book



\_\_\_\_\_ n

n n n n n

\_\_\_\_\_ n

n n n n n

Trace the letters.

Finish the maze.



uniform

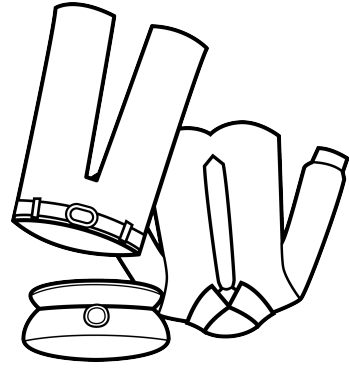

underwear

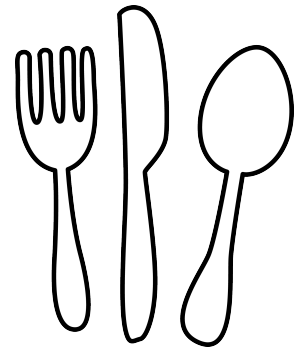
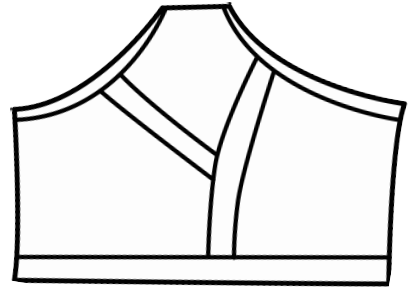

utensils

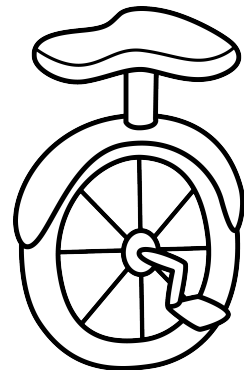

unicycle

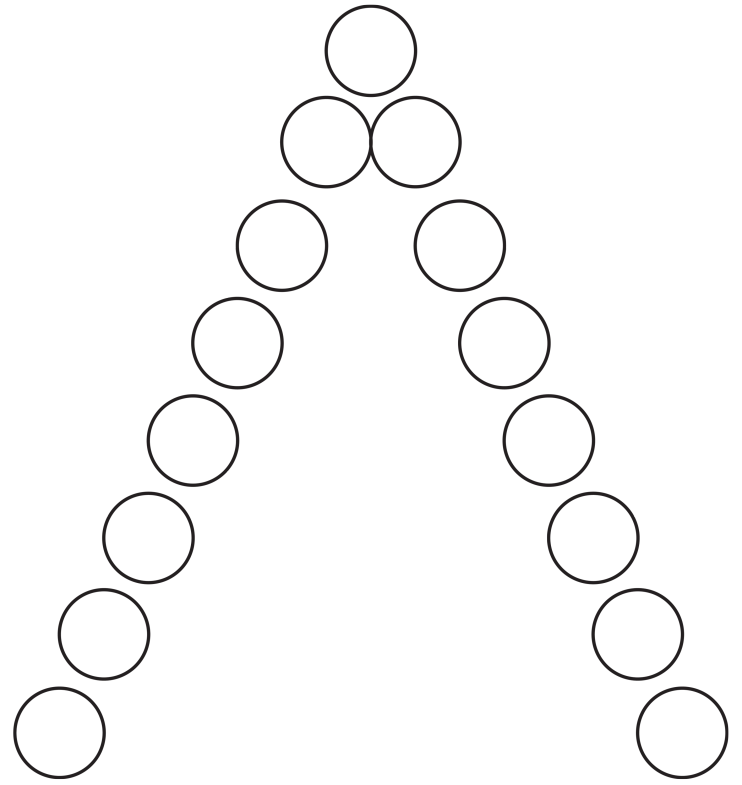
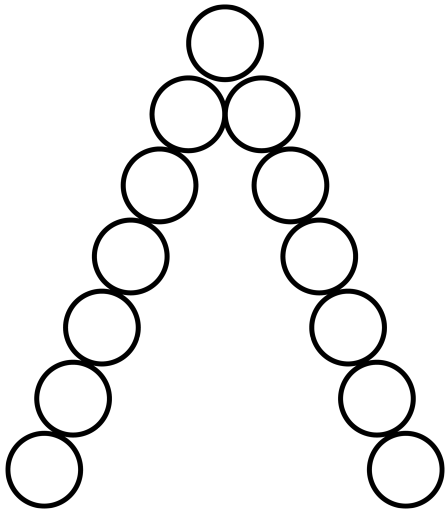

Vv words I know...



Book



Trace the letters.

Finish the maze.

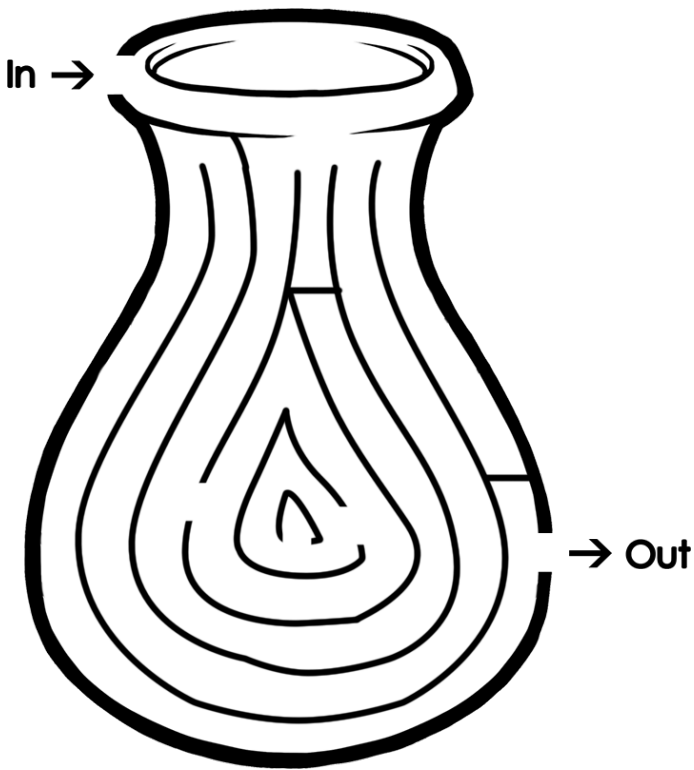

vegetables

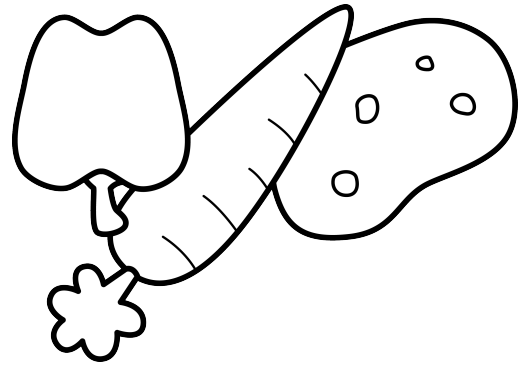

volcano

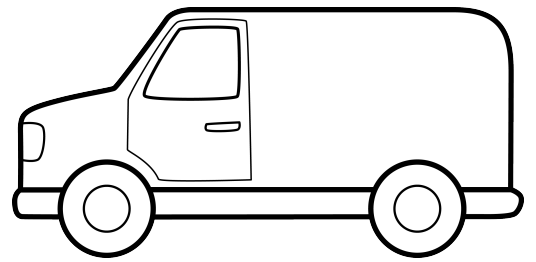
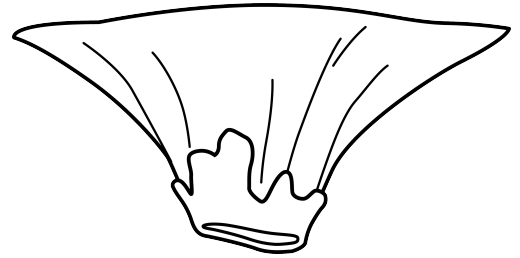

van

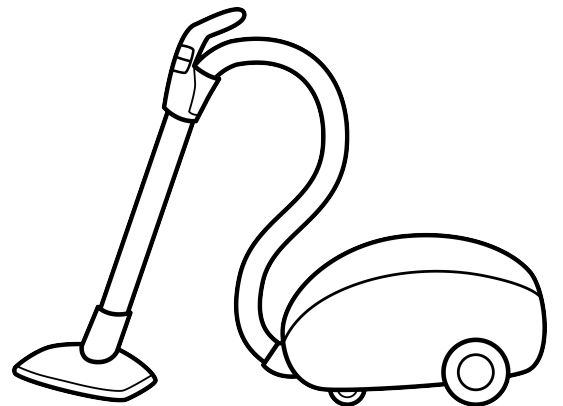

vacuum

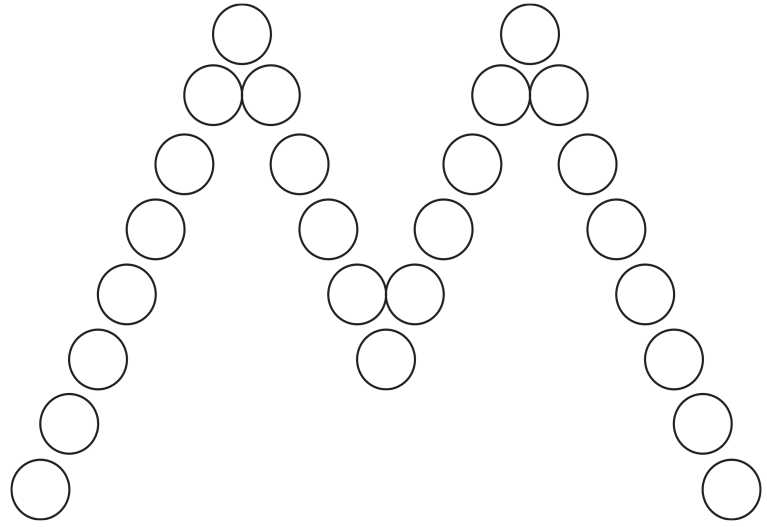
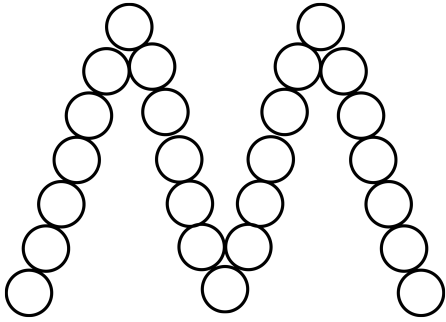

Ww words I know...

Letter

Ww

Book

W



W



Trace the letters.

Finish the maze.

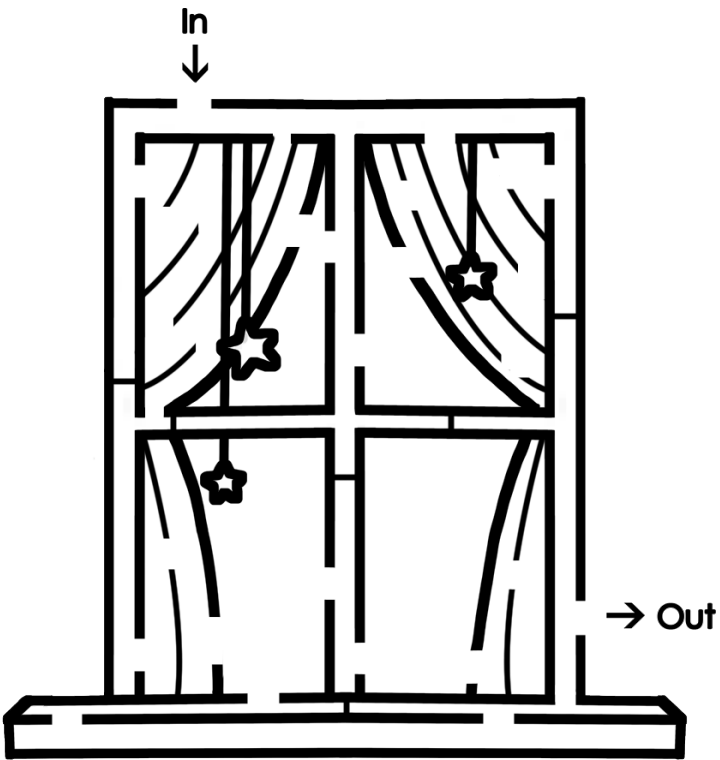

well

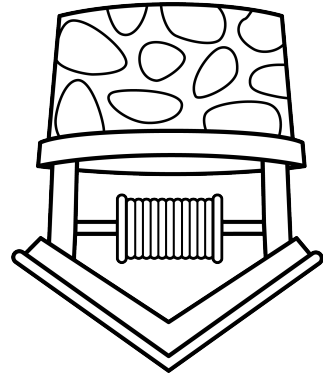

watermelon

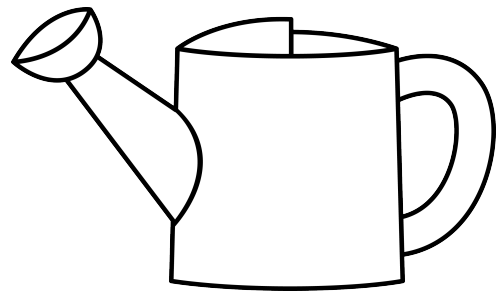
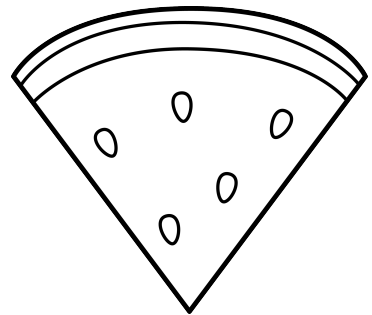

watering can

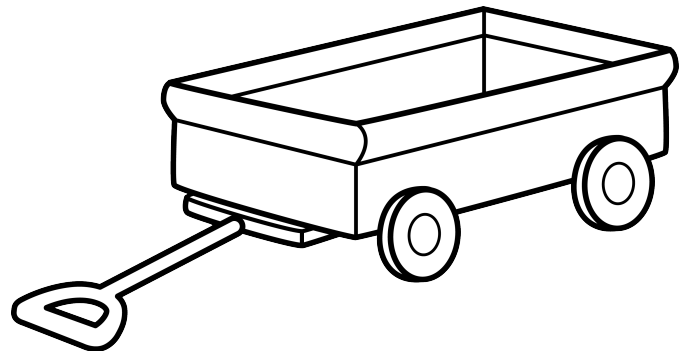

wagon

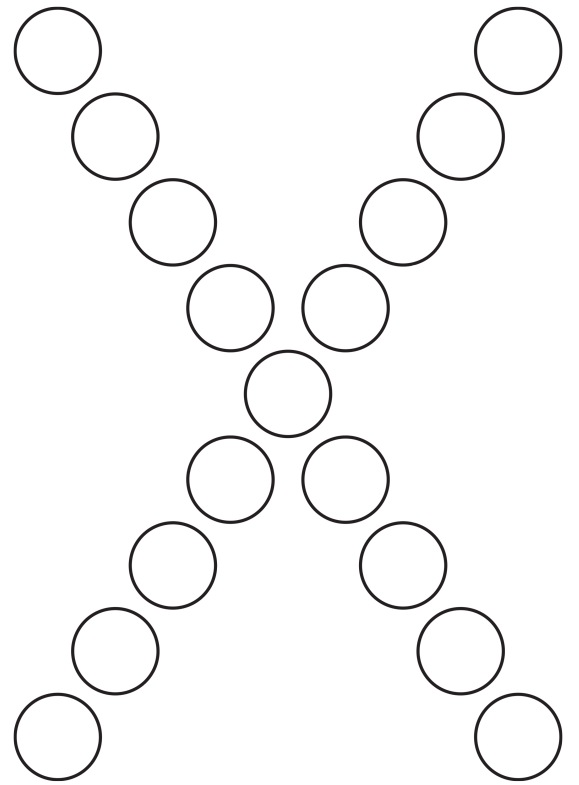
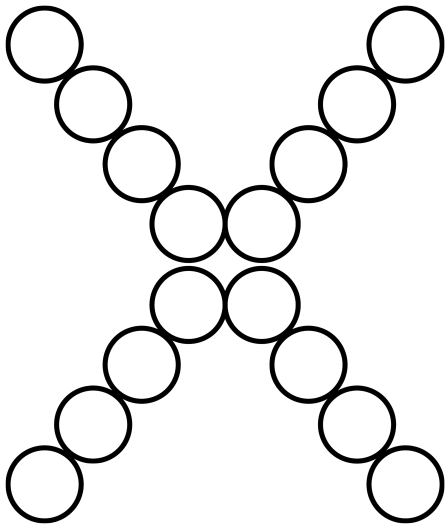

Xx words I know...

Letter

Xx

Book



Trace the letters.

Finish the maze.

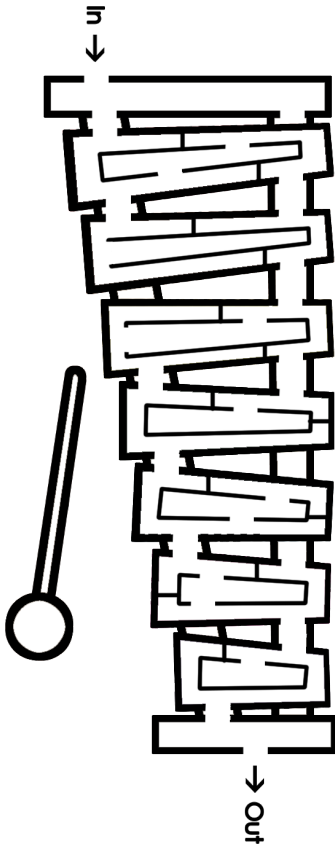

xylophone

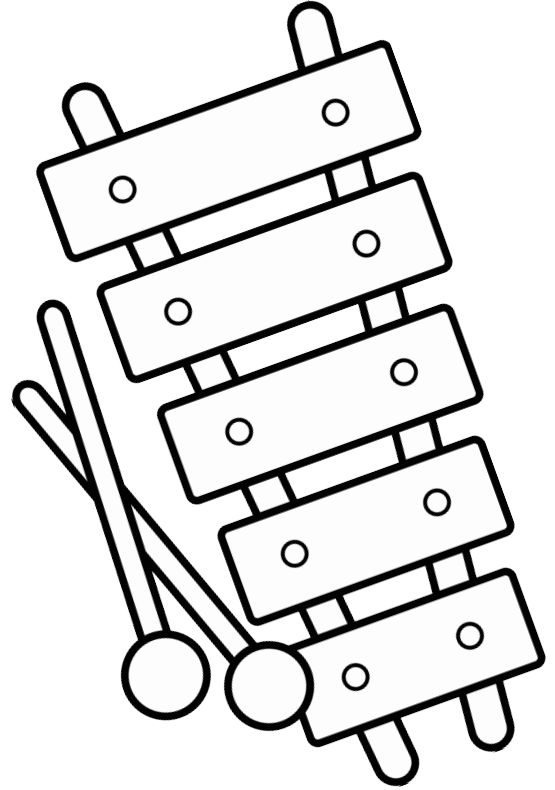

x ray

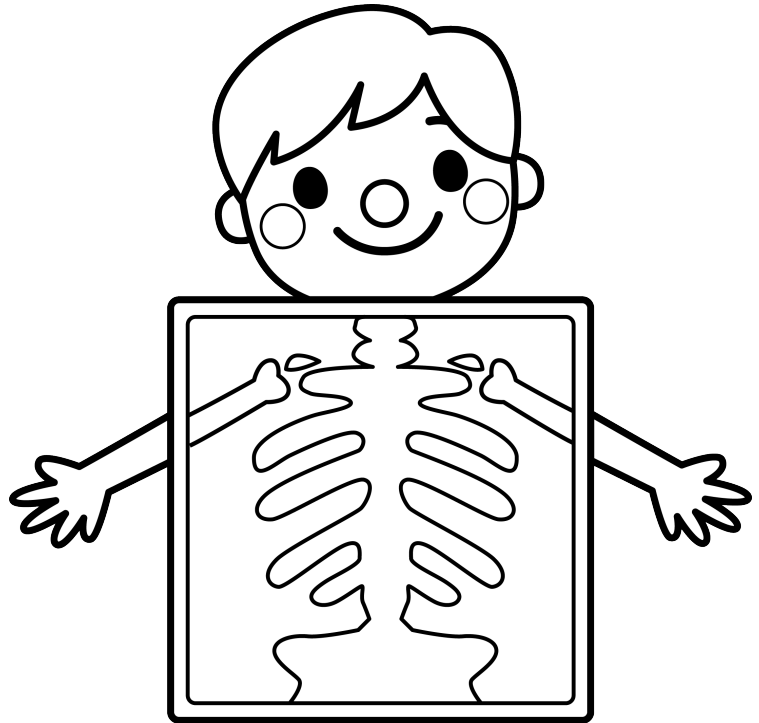

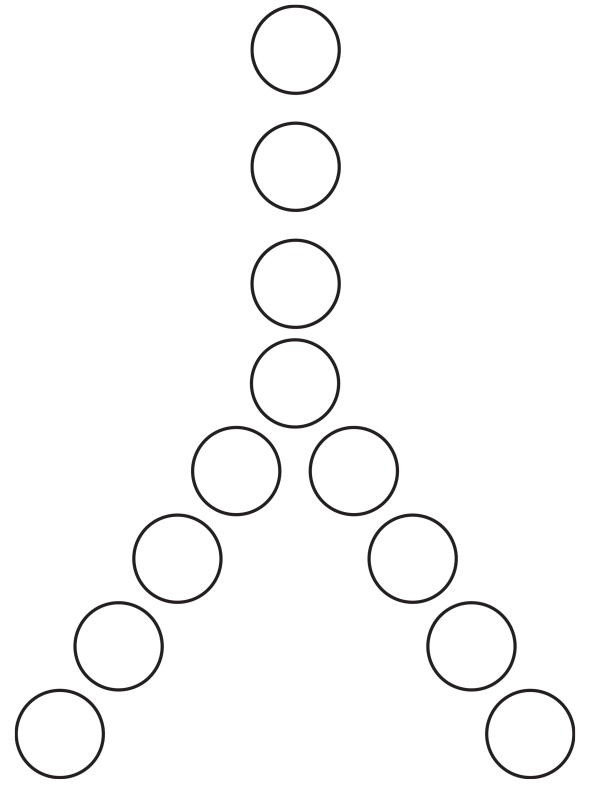
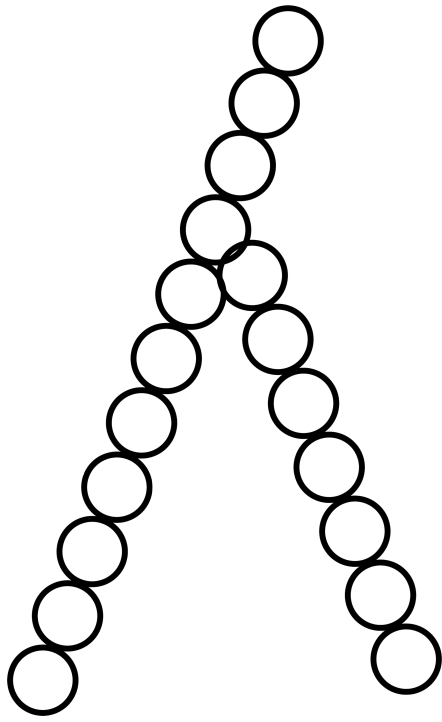

Yy words I know...

Letter

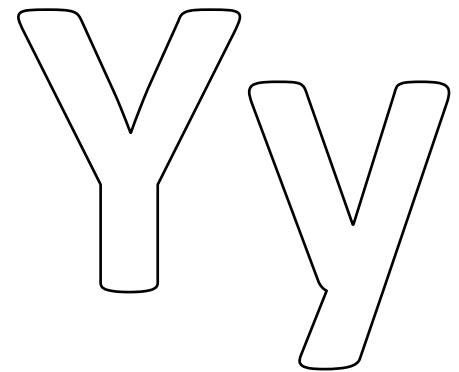

Book





Trace the letters.

Finish the maze.

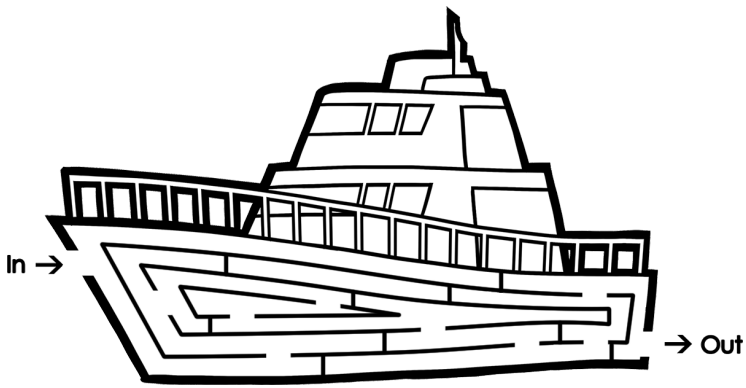

yarn

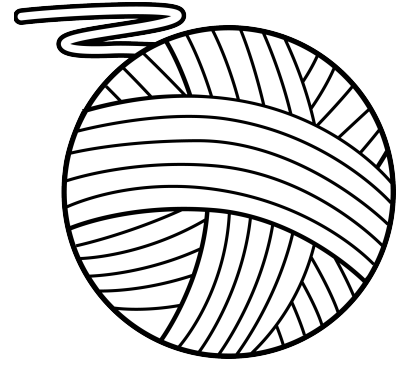

yams

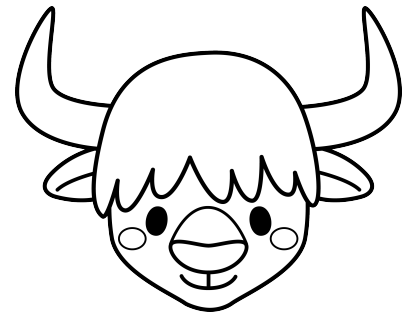
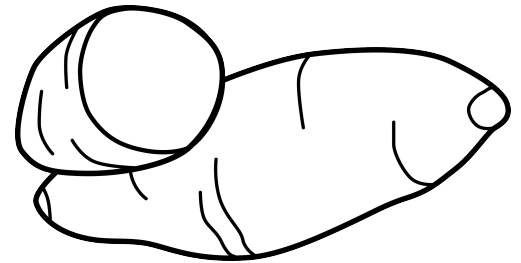

yak

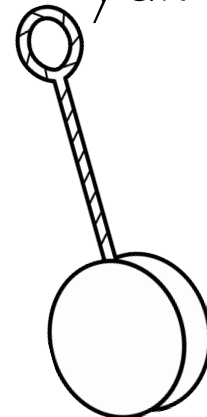

yoyo

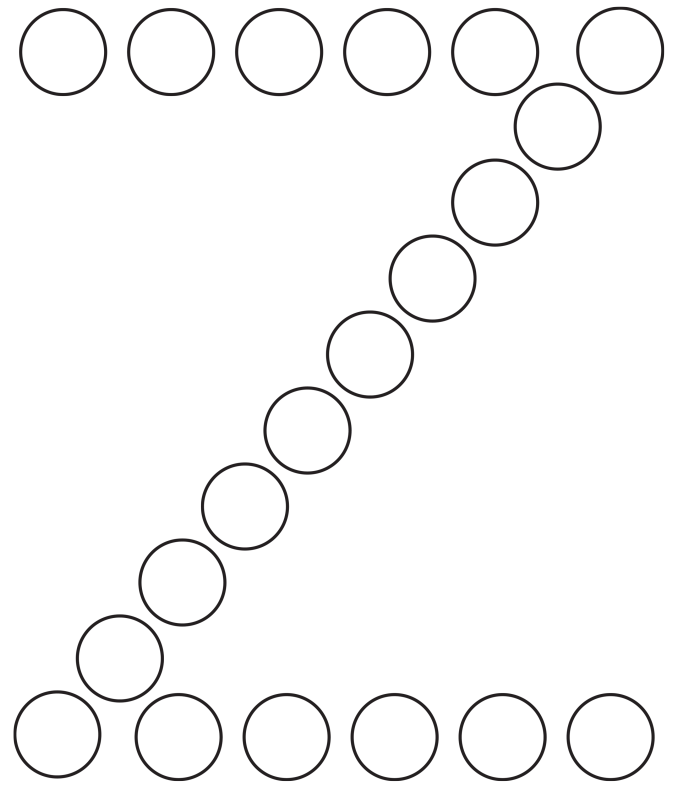
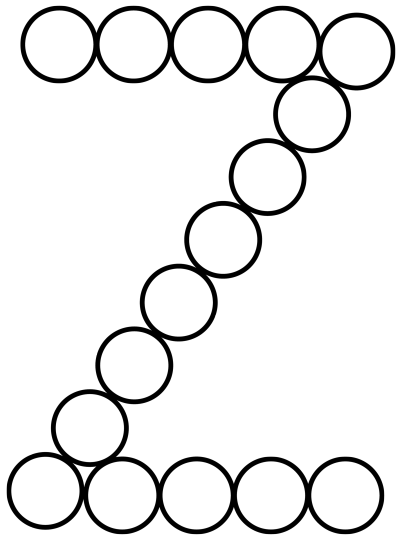

Zz words I know...

Letter

Zz

Book

\_\_\_\_\_ Z

z z z z Z

\_\_\_\_\_ Z

Z Z Z Z Z

Trace the letters.

Finish the maze.

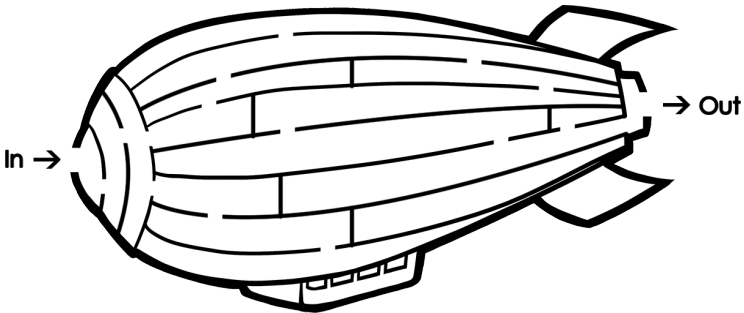

zeppelin

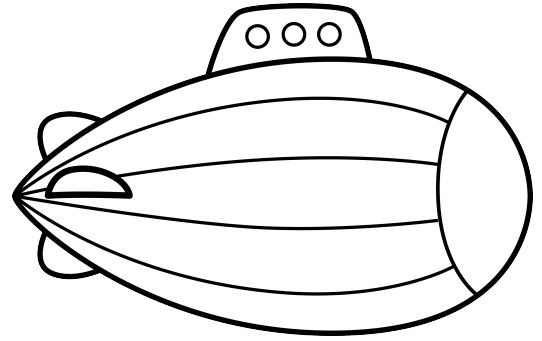

zipper



zebra



zucchini